



K-PATENTS PROCESS REFRACTOMETER PR-43-G

FOR IN-LINE CONCENTRATION MEASUREMENT IN INDUSTRIAL APPLICATIONS

TYPICAL APPLICATIONS

ALKALIES AND CHLORINE

Chlorine, Hydrochloric acid, Sodium hydroxide (Caustic soda), Sodium chloride (Brine), Sodium hypochlorite, Sulfuric acid.

CHEMICALS

Acetic acid, Acrylate, Amine oxide, Amino acid, Ammonium fluoride, Ammonium hydroxide, Ammonium nitrate, Ammonium sulphate, Caustic soda, Cellulose derivates, Citric acid, Copper chloride, Chromium trioxide (or Chromic acid), Ethyl alcohol, Ethylene glycol, Formaldehyde, Formic acid, Gelatine, Glycerol, Hydrogen peroxide, Iron chloride, Lactic acid, Lubricating oils, Nickel chloride, Nitric acid, Oleum, Polyamides, Polycarbonates, Polyethylene, Potassium compounds, Resins, Sodium alcinat, Sodium bicarbonate, Sodium dichromate, Sodium gluconate, Sodium hydroxide, Styrenes, Sulfuric acid, Urea, etc.

PLASTICS, RESINS, FIBERS AND SYNTHETIC RUBBER

Acetate, Acrylics, Adipic acid, Caprolactam, Cellulose acetate fibers, Cellulose triacetate (CTA), Cyclohexanol, Cyclohexanon, Dimethylterephthalate, Dimethylformamide, Fiberglass binder solution, Hexamethylene diamine, Nitrile butadiene rubber (NRB), Nylon salt, Polyamides, Polyesters, Rayon, Spandex, Synthetic latex, Vinyls. Finishing, coating and dyeing mediums of textiles.

METAL MACHINING AND MINING

Quenchants, cooling lubricants, cutting oils and coating fluids. Hydraulic emulsions, longwall emulsions. Alumina mining: Caustic soda.

SALTS AND SODIUM COMPOUNDS

Brine, Glauber's salt, Sodium carbonate, Sodium chloride, Sodium sulfate, Sodium sulfite, etc.

EFFLUENT AND WATER TREATMENT

Surface water treatment by chemical precipitation: Polyaluminium chloride, Sodium hydroxide, Sodium hypochlorite. Ammonia removal in underground water treatment: Ammonium sulfate. Total organic carbon (TOC) content monitoring in effluent: dissolved organic material.

OTHER

Ion exchange chromatography: regeneration chemicals of ion exchangers. Loading and unloading operations: chemicals interface detection and identification. De-icing preparations manufacturing, spraying and recovery: Ethylene glycol, Propylene glycol. Automotive grade urea solution, AdBlue (AUS32), Diesel exhaust fluid (DEF). Removal of Polycyclic aromatic hydrocarbons (PAH) in green automotive tires production: extender oil. Sugar, starch sweeteners: sucrose, fructose, dextrose. Wood timber treatment and acetylation: Acetic anhydride. And more.



PERFORMANCE OVERVIEW

REFRACTOMETER TECHNOLOGY

K-Patents Process refractometer PR-43-G is designed to measure, refine, manage and indicate liquid concentration and diagnostic information in the end users' diverse general-purpose process industry applications. The PR-43-G combines high accuracy measuring technology with industrial grade ruggedness.

The PR-43-G Refractometer system consists of a compact or probe refractometer and a graphical user interface. The refractometer is a stand-alone device capable of operating independently. It has a measurement range of 0 to 100 % and provides an Ethernet or 4–20 mA output signal proportional to the temperature-compensated concentration value for real-time process control. Different user interface options range from a rugged, multichannel, industrial computer to a compact light-weight and a web-based version, and allow the user to select the most preferred way to access and use the refractometer measurement and diagnostics data.

PR-43-G Refractometer has a built-in web server with an instrument homepage. The homepage allows for configuring, monitoring, verifying and diagnosing the refractometer via an Ethernet connection. Every PR-43-G Refractometer also provides an mA output signal for control purposes.

The Process refractometer PR-43-G is factory-calibrated to measure concentration and temperature in standard units. Each refractometer has identical calibration. For this reason, the refractometers can be freely interchanged without optical recalibration or parameter changes. The refractometer does not require any recalibration or regular maintenance. Furthermore, the calibration of each refractometer can be verified using standard refractive index liquids and a built-in verification procedure.

DESIGNED FOR HARSH ENVIRONMENTS

K-Patents Process refractometer PR-43-G offers accuracy, repeatability and reliability even in the most extreme environments that can be corrosive, abrasive, subject to extreme temperatures, pressures, vibration or contamination, humidity and dust, or any combinations of these factors.

- Designed to Pressure Equipment Directive PED 97/23/EC and ASME Section VIII Division 1 - Pressure Vessels.
- The refractometer wetted parts construction has no welds for increased safety.
- Selection of different IP codes (IEC 60529) and NEMA ratings for the refractometer and user interface that withstand various harsh conditions.
- Special wetted parts materials are available for harsh environments and aggressive process fluids.
- Intrinsically safe and hazardous area certification is provided for hazardous areas.
- Material traceability certification conforming to EN 10204 3.1.
- Also third party inspections and documents can be ordered.
- When standard model codes are not sufficient to fulfill requirements, please consult the factory for engineered solutions, e.g. special wetted materials or custom process connections. The engineered solutions may be subject to additional delivery time.

REFRACTOMETER INSTALLATION

The Process refractometer PR-43-G is installed in the main processing line, bypass line or vessel either directly with Flange or Sandvik coupling process connection, or via a large variety of cost-effective and easy to mount flow cell options. The user interface of the refractometer can be installed locally in the field, remotely in the control room or in both locations by connecting several user interfaces in a network.

COMPACT PROBE

Sandvik L coupling and wafer flow cell connection for 0.5" and 1"

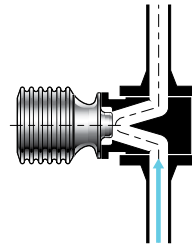

Sandvik L coupling and pipe flow cell connection for 1"

LONG PROBE

Flange and flow through cell connection for 1"

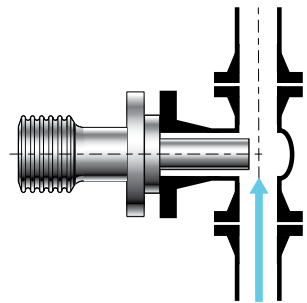

Sandvik coupling or flange connection for 2" and larger

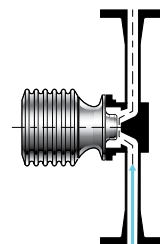

Sandvik L coupling connection for 2" or larger

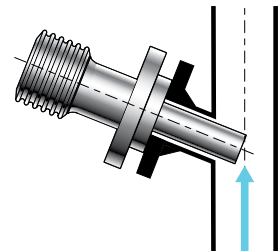

Sandvik coupling or flange connection for vessel

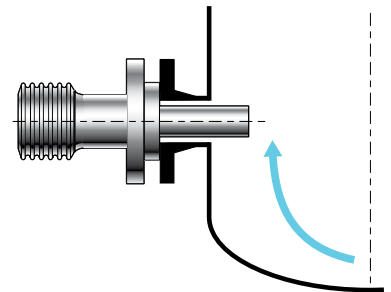
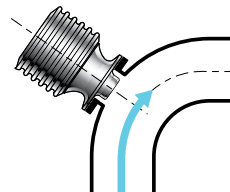

STANDARD PACKAGES

REFRACTOMETER
PR-43-G



MULTICHANNEL USER
INTERFACE MI



PROCESS REFRACTOMETER
PR-43-G AND MULTICHANNEL
USER INTERFACE MI

K-Patents fully equipped system with refractometer, interconnecting cable and multichannel user interface with high performance industrial computing, wash control and high expandability capabilities and connectivity.

The multichannel user interface MI provides the highest level of industrial computing, intelligence and sophisticated features as well as environmental protection.

REFRACTOMETER
PR-43-G



COMPACT USER
INTERFACE CI



PROCESS REFRACTOMETER
PR-43-G AND COMPACT
USER INTERFACE CI

K-Patents compact, single device connectivity system with refractometer, interconnecting cable and compact user interface for applications where a local or remote display and access is preferred and where no wash is required.

REFRACTOMETER
PR-43-G



WEB USER
INTERFACE WI

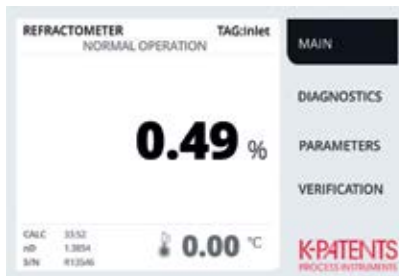

PROCESS REFRACTOMETER
PR-43-G AND WEB USER
INTERFACE WI

K-Patents stand-alone system with refractometer, interconnecting cable and web user interface designed particularly for direct control system integration in applications where no industrial computer (e.g. to control prism wash) or monitoring display is required.

USER INTERFACES

K-Patents Process refractometer PR-43-G can be equipped with different user interface options for handling the user and refractometer as well as refractometer and control system interaction.

MULTICHANNEL USER INTERFACE MI

- High-performance, industrial computing system
- Expandable system and connectivity for up to four (4) PR-43-G refractometers and eight (8) I/O modules
- Environmentally sealed IP67, Type 4X, rugged 316 stainless steel enclosure that withstands the corrosive cleaning agents and frequent washes
- Ideal for demanding field and outdoor conditions (0–50°C, 32–122°F)
- Prism wash diagnostics and control
- Trend display that shows one or two graphs over a selected period of time
- Embedded measurement apps: The apps are small programs that give different types of measurement data and functionality.
- Modules, e.g. mA-output and mA-input module
- 10" graphical touchscreen color display
- 21 CFR 11 compliant user identification and management, electronic data records and data-logging, event log/audit trail

COMPACT USER INTERFACE CI

- Single device connectivity
- Local and/or remote display and access
- Light-weight, aluminum enclosure for control room conditions and epoxy coated IP66, Type 4X enclosure with polycarbonate display shield for field conditions
- Trend display
- 10" graphical touchscreen color display.

WEB USER INTERFACE WI

- Web browser interface via Ethernet connection to a control system or any type of computer
- Output values are transmitted through 4-20 mA output and output values, diagnostic information and trends are transmitted via an Ethernet connection using a UDP/IP protocol

FIELD COMMUNICATOR FC-11

The user can remotely operate and configure the refractometer using the K-Patents hand-held Field Communicator FC-11. The FC-11 provides an identical window into the process, showing measurement and diagnostic data including the optical image, and facilitating real time analysis and configuration directly at the refractometer.

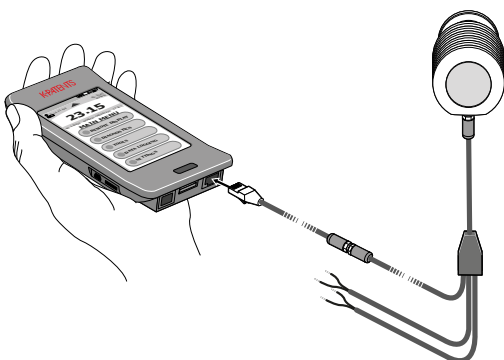

MI AND CI DISPLAYS

Main output display for four (4) measurement apps



Diagnostics display

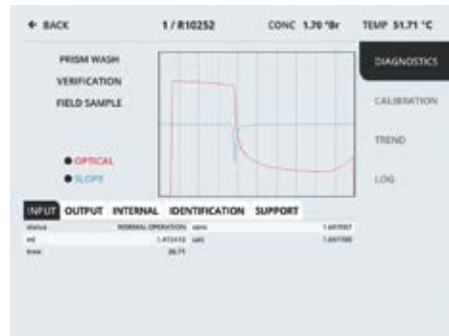

Trend display



User authentication with user ID and password



PRINCIPLE

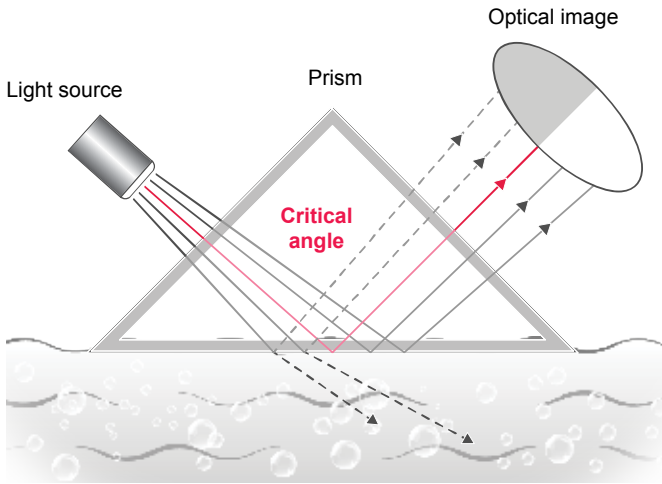

DIGITAL MEASUREMENT PRINCIPLE

The light source sends light to the interface between a prism and the process solution, where the rays meet the surface at different angles. Depending on the angle, some rays undergo a total internal reflection. The rest of the light is refracted into the process solution.

Thus, an optical image with a dark sector and a light sector is created. The angle corresponding to the shadow line is called the critical angle of total internal reflection.

This angle is a function of the refractive index and therefore the concentration of the solution. A CCD-camera detects the optical image. The image is transformed point-by-point into a digital signal. Digital signal processing is used to locate the exact shadow line position and to determine the refractive index nD.

A built-in temperature sensor measures the temperature T on the interface of the process liquid. The sensor converts the refractive index nD and temperature T into Brix units.

The diagnostics program ensures that the measurement is reliable.

CALIBRATION

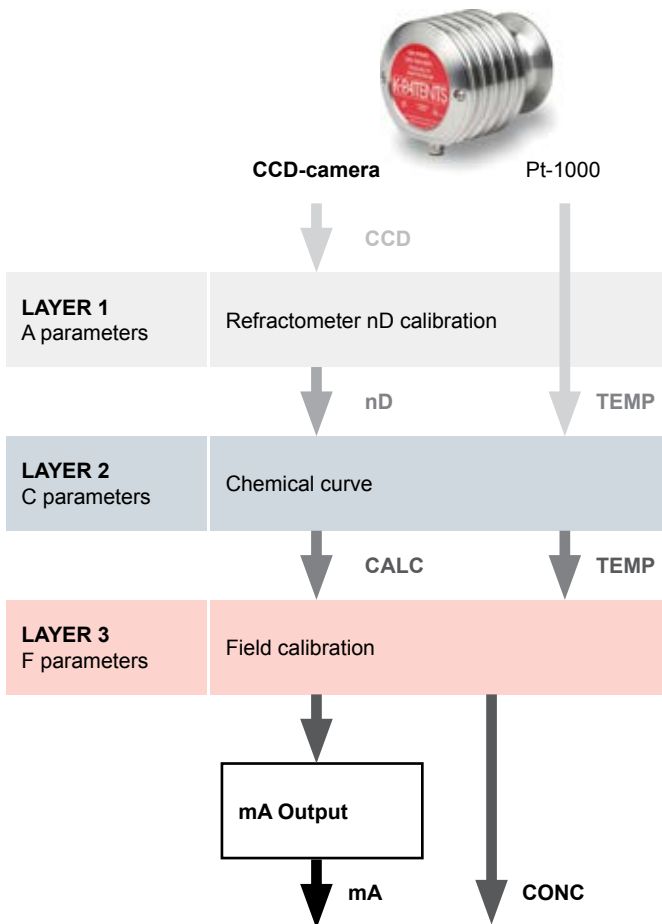

UNIQUE 3-LAYER CALIBRATION

The concentration calibration of the K-Patents PR-43-G refractometer is organized in three (3) layers: the Refractometer nD calibration, chemical curve and field calibration. The advantages of the layer feature are free interchangeability of refractometers, applications and recipes without any need for mechanical calibration adjustment in the field.

The optical image information is detected by the CCD-element and transformed into a number (CCD). The process temperature T is measured by a Pt-1000 resistance.

LAYER 1:
The refractometer calibration: The actual refractive index nD is calculated from the CCD.

LAYER 2:
The chemical curve: The refractometer calculates the Brix or concentration value based on nD and TEMP. The result is a temperature compensated calculated concentration value CALC.

LAYER 3:
Field calibration: Adjustment of the calculated concentration value CALC may be required in order to compensate for some process conditions or to fit the measurement to the laboratory results. The Field calibration procedure determines the appropriate adjustment to CALC. The adjusted concentration is called CONC.

Output signal: The output signal is transmitted over the 4–20 mA current output or through the Ethernet connection.

DESIGN

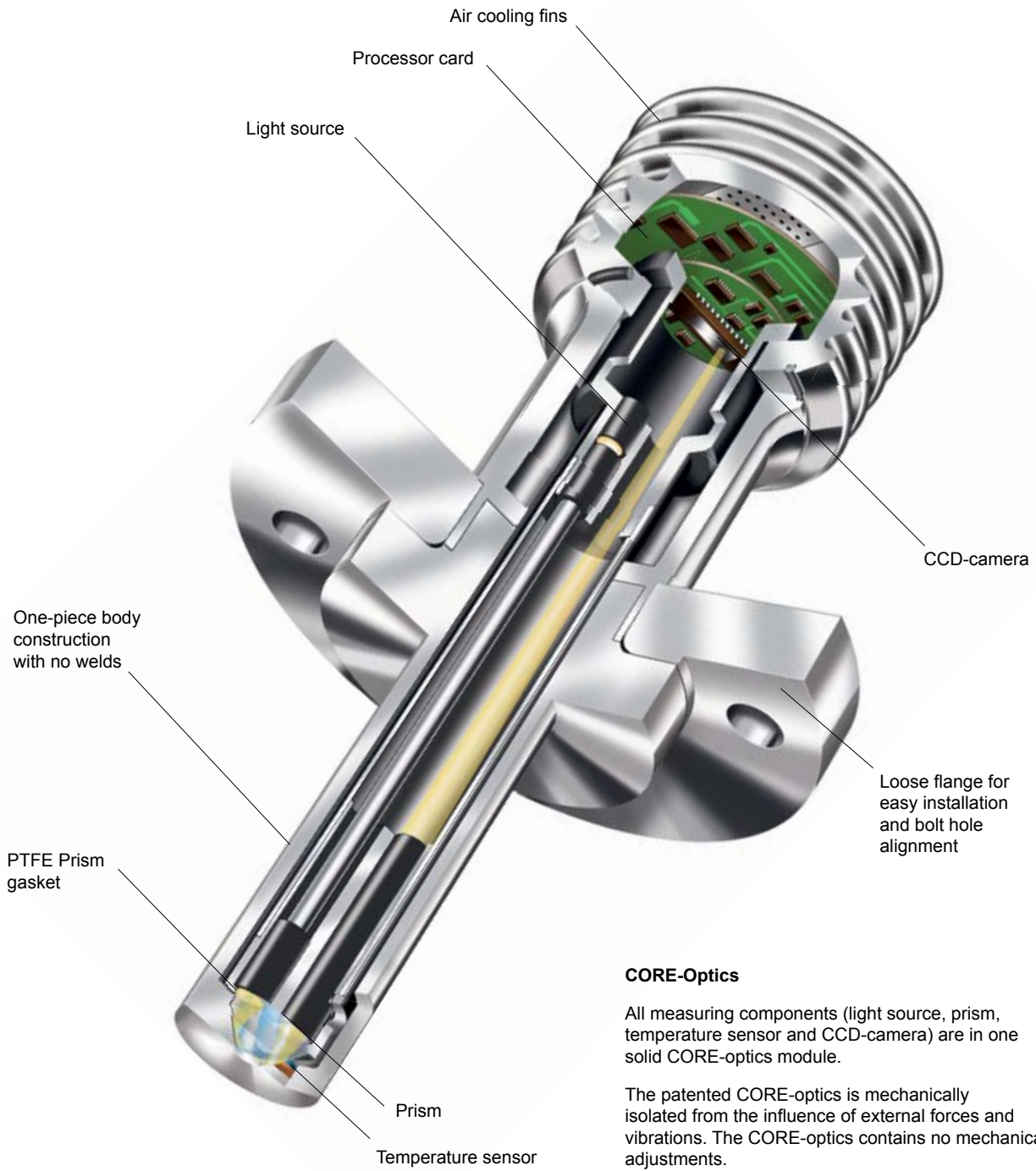

SPECIFICATIONS

REFRACTOMETER PR-43-G	Standard	Optional
REFRACTOMETER MODELS	PR-43-GC Compact model; PR-43-GP Probe model	
Refractive Index range	Full range, nD = 1.3200...1.5300 corresponds to hot water...100 % by weight.	nD = 1.260...1.470 nD = 1.410...1.620 nD = 1.520...1.730
Accuracy	Across the full range of 0–100 %: Refractive index nD ± 0.0002 corresponds typically to ± 0.1 % by weight.	
Repeatability	Across the full range of 0–100 %: nD ± 0.00004 (corresponds typically to ± 0.02 % by weight).	
Speed of response	1 s undamped, damping time selectable up to 5 min.	
Calibration	With NIST traceable Cargille standard R.I. liquids over full range.	
Patented CORE-Optics	No mechanical adjustments and digital measurement with 3648 pixel CCD element, sodium D-line light emitting diode (LED), built-in Pt-1000 temperature sensor (linearization according to IEC 751).	
Temperature compensation	Automatic, digital compensation.	
Instrument verification	With NIST traceable Cargille standard R.I. liquids and guided procedure, including a printable verification report.	
Process connection	PR-43-GC: Sandvik coupling L 60.3 mm (2 inch) for pipe size of 2 inch; via reducing ferrule PR-9285 for pipe size of 1.5 inch. PR-43-GC: Sandvik coupling L 76.1 mm (2.5 inch) for pipe sizes of 2.5 inch and larger; via Wafer flow cell WFC for pipe sizes of 0.5 inch, 1 inch or 1.5 inch. Wafer flow cell body mounts between ANSI 150 lbs, DIN PN 25 or JIS; via Pipe flow cell PFC for pipe line size of 1 inch. Pipe flow cell process connection with ANSI 150 lbs, DIN PN 25 or JIS 10K. PR-43-GP: ANSI 2 inch, 3 inch or 4 inch with 150 lbs or 300 lbs, DN50, 80 or 100 PN25, JIS 50A, 80A or 100A with 10K; Sandvik L coupling 88 mm (3 inch); via Flow through cell FTC for pipe sizes of 1 inch or 2 inch. Flow through cell process connection with ANSI 150 lbs or 300 lbs, DIN PN25 or JIS 10K.	
Process pressure	PR-43-GC: Sandvik coupling L 76.1 mm (2.5 inch) up to 25 bar (350 psi)/Sandvik L 60.3 (2 inch) up to 40 bar (580 psi) at 20°C (70°F); PR-43-GP: flange and L coupling connections up to 25 bar (350 psi) at 20°C (70°F).	
Process temperature	PR-43-GC: -40°C...130°C (-40°F...266°F), PR-43-GP: -40°C...150°C (-40°F...302°F).	
Ambient temperature	Refractometer: min. -40°C (-40°F), max. 45°C (113°F); for higher ambient temperatures a cooling cover for refractometer electronics housing is available; Multichannel user interface MI: min. 0°C (32°F), max. 50°C (122°F); Compact user interface CI: min. 0°C (32°F), max. 50°C (122°F)	
Process wetted parts	AISI 316L stainless steel, prism sapphire, prism gasket modified PTFE.	Alloy 20 Hastelloy C276/ASTM C276 Nickel 200/201 Titanium GR2/ASTM B348 GR2
Refractometer protection class	IP67, Type 4X (for outdoor use).	
Refractometer weight	PR-43-GC (2 inch): 1.7 kg (3.7 lbs), PR-43-GP (2 inch): 6.7 kg (14.8 lbs).	
Current output	Isolated 4–20 mA, max. load 1000 Ohm, galvanic isolation 1000 VDC or AC (peak), hold function during prism wash.	
Remote and Ethernet connections	10/100BaseT Ethernet, web server for configuration and diagnostics, UDP/IP Protocol connection for data acquisition.	
INTERCONNECTING CABLES	Standard length 10 m. Interconnecting cable length is field-adjustable with Platform 4 Cable extender for up to 100 m.	
USER INTERFACE MODELS	Multichannel user interface MI, Compact user interface CI, Web user interface WI	
Multichannel user interface MI	Environmentally sealed 316 stainless steel IP67 (door closed), IP66 (door open)/Type 4X for demanding field and outdoor conditions. Prism wash diagnostics and control. Trends, Apps. Eight (8) module slots. 10" graphical touchscreen color display with door. 21 CFR 11 compliant user authentication with user ID and password, electronic records and data-logging, event log/audit trail. Expandable system and I/O options: connect up to four (4) PR-43-G refractometers and up to eight (8) I/O modules. Wall and table-top mount.	
Compact user interface CI	Light-weight aluminum enclosure for control room conditions; Epoxy coated IP66, Type 4X enclosure with polycarbonate display shield for field conditions. Trends. 10" graphical touchscreen color display. Wall, table-top and panel mount.	
Web user interface WI	Output values are transmitted through 4–20 mA output and output values, diagnostic information and trends are transmitted via Ethernet connection using a UDP/IP protocol.	
User interface weight	Multichannel user interface MI: 13.6 kg (29 lbs), Compact user interface CI: 5.4 kg (11 lbs)	
POWER SUPPLY	Refractometer: +24 VDC +/-10%, Max 2 VA; Multichannel user interface MI: AC input 100-240 VAC/50-60HZ or 24 VDC, 60W; Compact user interface CI: +24 VDC +/-10%, Max. 8.5W.	
OPTIONS	Prism wash, Hazardous and intrinsic safety approvals for hazardous area installations.	
SERVICES	To ensure continuous support before and after purchase of our products, we offer local application consultation, training, maintenance and support expertise via our authorized sales representative network. Please refer to www.kpatents.com to contact your nearest representative.	
PATENTS	See www.kpatents.com	

We reserve right to technical alterations.

K-PATENTS OY
P.O. BOX 77
ELANNONTIE 5
FI-01511 VANTAA, FINLAND
PHONE: INT.+358-207-291 570
FAX: INT.+358-207-291 577
INFO@KPATENTS.COM
WWW.KPATENTS.COM

K-PATENTS, INC.
1804 CENTRE POINT CIRCLE, SUITE 106
NAPERVILLE, IL 60563
U.S.A.
PHONE: (630) 955 1545
FAX: (630) 955 1585
INFO@KPATENTS-USA.COM
WWW.KPATENTS.COM